

Data Sheet



Article number: 021816011267

Description: Clamp with bracket and rubber
SPGU 6011. 267/30 SK

Measures

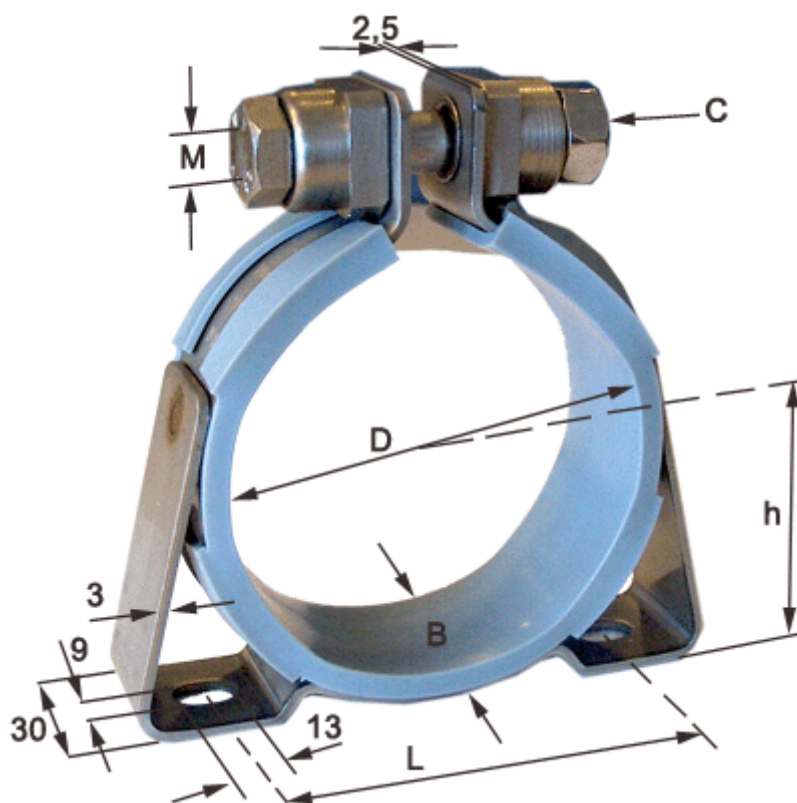

C (screw type) = SK hexagon screw

Diameter D = 267

h = 142

L = 248

Width B = 30